

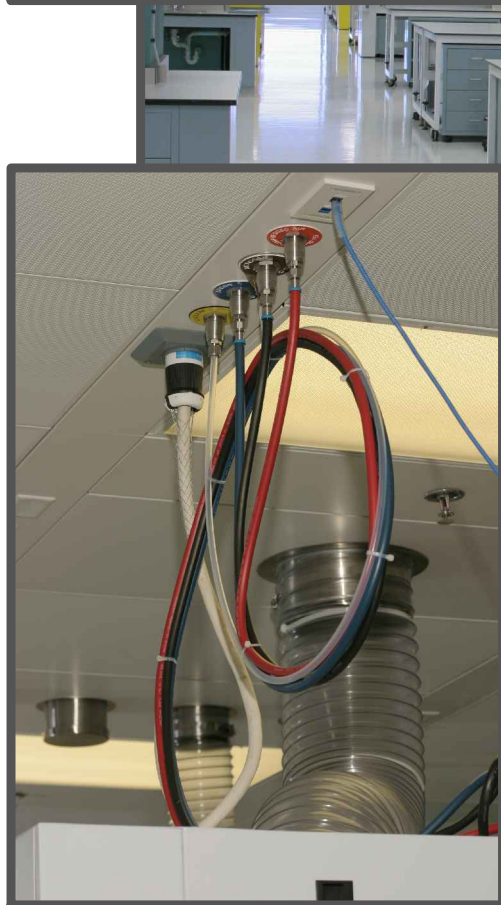

LF SYSTEMS CORP

● LABORATORY FURNITURE ● DESIGN, SALES, INSTALLATION & FUME HOOD MAINTENANCE ●
● 302 322 0460 ● CONTACTUS@LFSYSTEMS.COM ● ● WWW.LFSYSTEMS.COM ●

Flexilab Furniture System



PROJECT

- LF SYSTEMS FLEXILAB SYSTEM -

249 OLD CHURCHMANS RD
NEW CASTLE, DE 19720
PHONE: 302-322-0460
FAX: 302-322-2849



SCALE
NONE

DATE
01-01-18

DRAWN BY:
JMN

CHK'D BY:
GFH

JOB NO.
XXXX

SHEET NO.
00

REV. 0

STANDING HEIGHT MOBILE TABLES: (36-1/4" HIGH / 30" DEEP)

MTF-4830

MTF-5430

MTF-6030

MTF-6630

MTF-7230

MTF-8430

MTF-9630

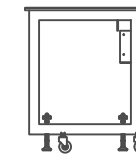
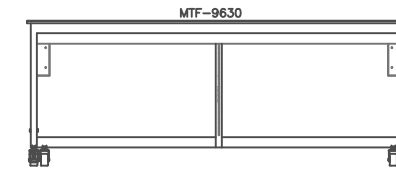
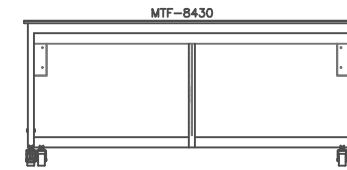
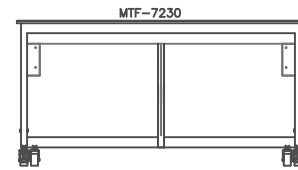
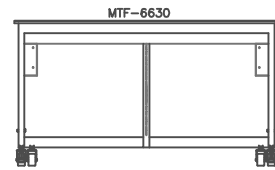
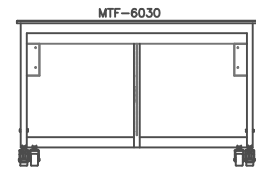
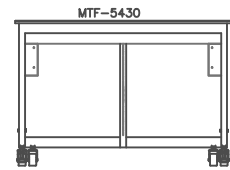
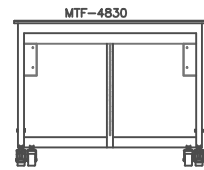
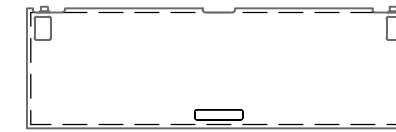
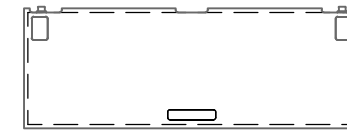
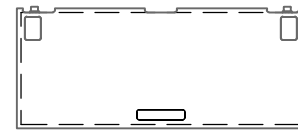
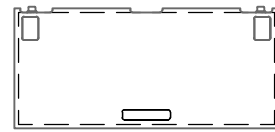
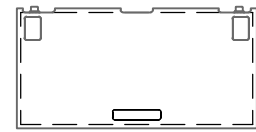
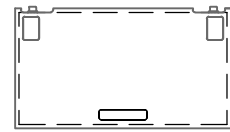
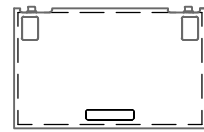

STANDING HEIGHT MOBILE TABLES: (36-1/4" HIGH / 36" DEEP)

MTF-4836

MTF-5436

MTF-6036

MTF-6636

MTF-7236

MTF-8436

MTF-9636

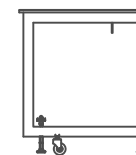
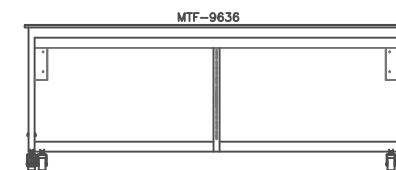
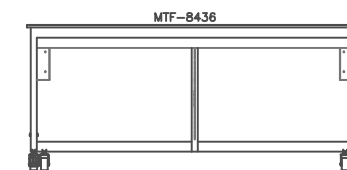
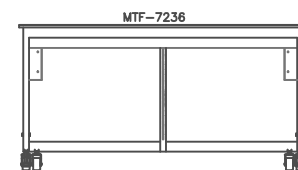
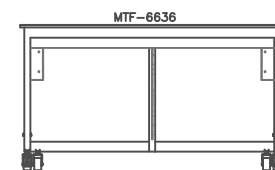
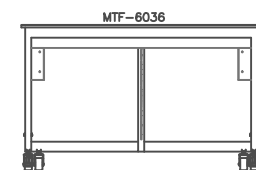
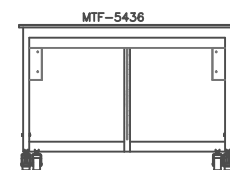
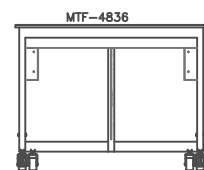
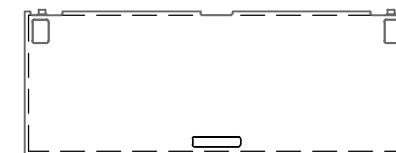
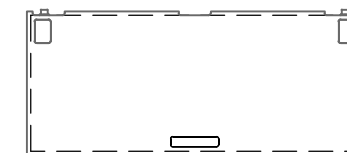
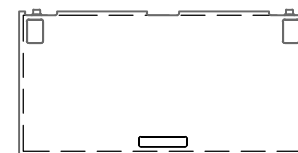
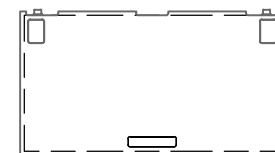
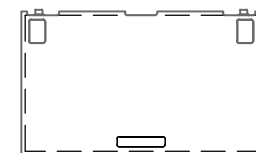
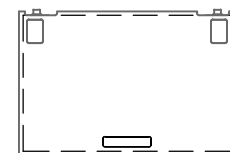
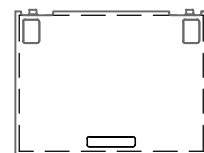

STANDING HEIGHT "C" MOBILE CABINETS: (32-5/8" HIGH / 22" DEEP)

- WORK SURFACE/COUNTERTOP SUPPLIED BY LF SYSTEMS:
(1/4" THICK PHENOLIC RESIN WITH 1/4" OVERHANG ON ALL EDGES)

M1C-18 M1C-24

M1C-30

M1C-36

M1C-42

M2C-18

M2C-24

M2C-42

M12C-30

M12C-36

M3C-30

M6C-30

M7C-18

M7C-24

M7C-30

M7C-36

M8C-42

M9C-42

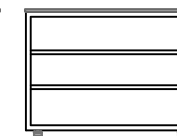
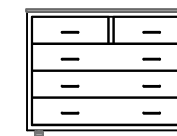
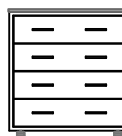
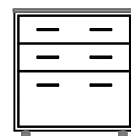
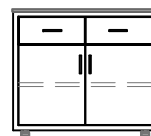
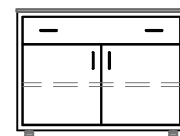
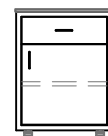
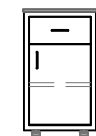
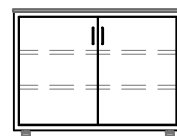
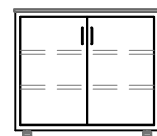
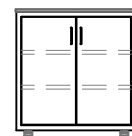
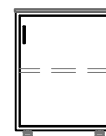
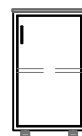

SITTING HEIGHT MOBILE TABLES: (30-1/4" HIGH / 30" DEEP)

MTFL-4830

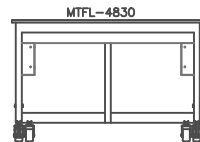
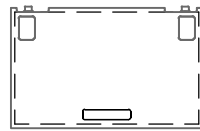

MTFL-6030

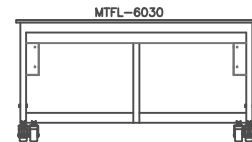
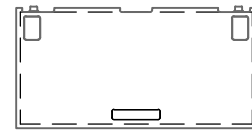

MTFL-7230

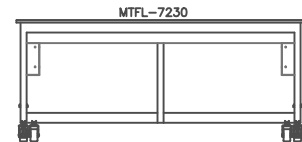
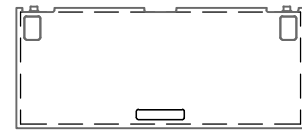

MTFL-8430

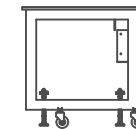
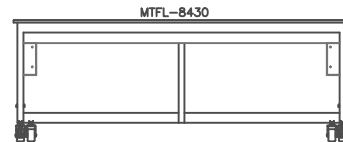
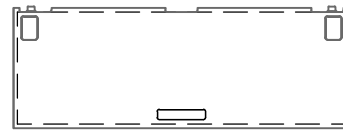

SITTING HEIGHT MOBILE TABLES: (30-1/4" HIGH / 36" DEEP)

MTFL-4836

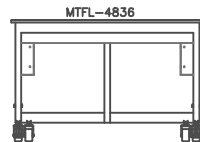
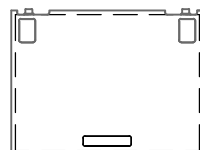

MTFL-6036

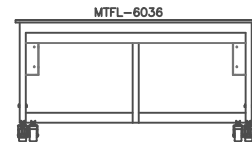
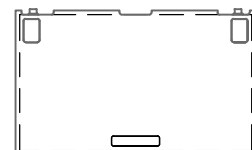

MTFL-7236

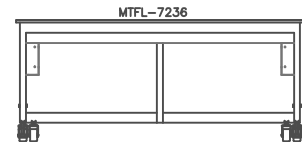
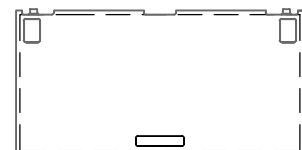

MTFL-8436

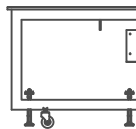
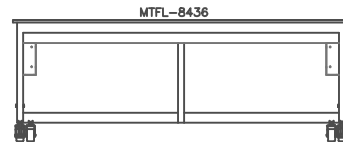
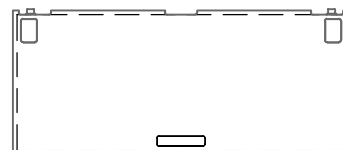

SITTING HEIGHT "D" MOBILE CABINETS: (26-5/8" / 22" DEEP)

- WORK SURFACE/COUNTERTOP SUPPLIED BY LF SYSTEMS:
(1/4" THICK PHENOLIC RESIN WITH 1/4" OVERHANG ON ALL EDGES)

M1D-24LH

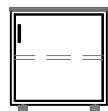

M1D-24RH

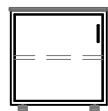

M1D-30



M1D-36

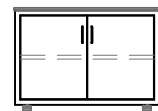

M1D-42

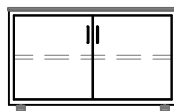

M3D-30

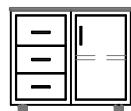

M7D-18



M7D-24



M7D-30

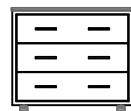

M7D-36

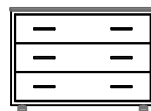

M8D-42

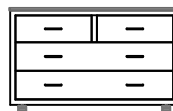

M9D-42

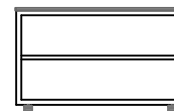

STANDING HEIGHT MOBILE TABLES: (48" DEEP)

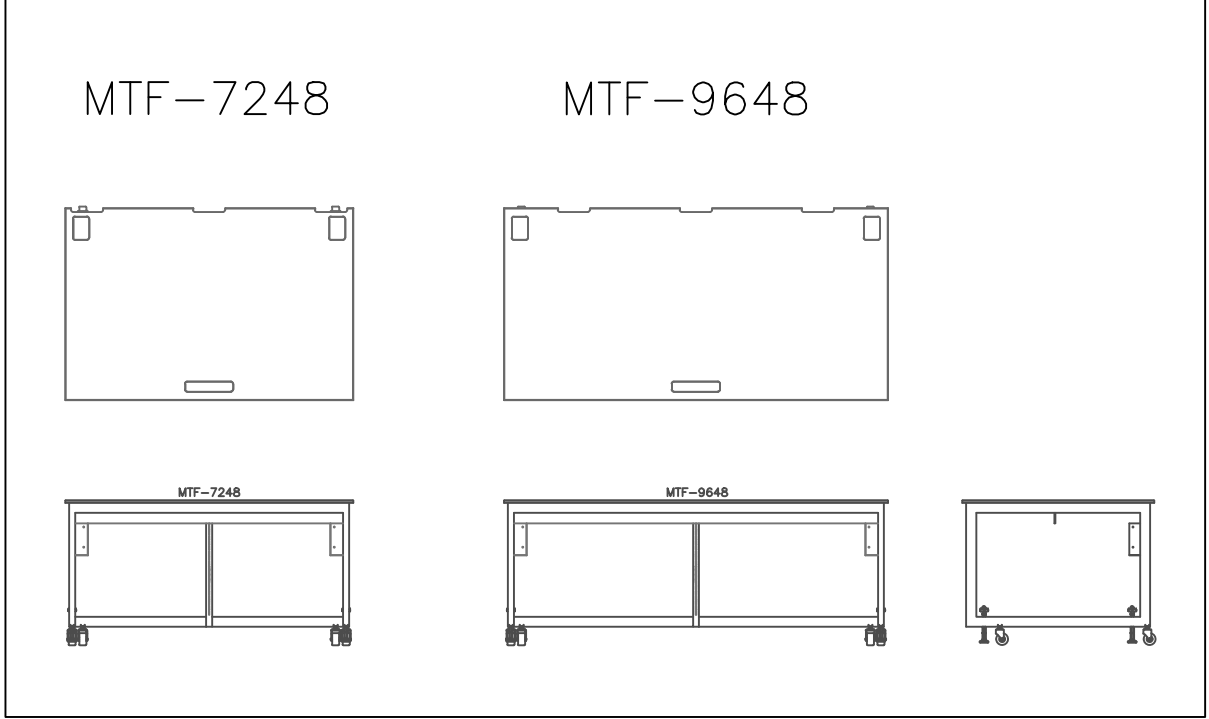

STANDING HEIGHT MOBILE TABLES: (48" DEEP, CENTER CONFIG.)

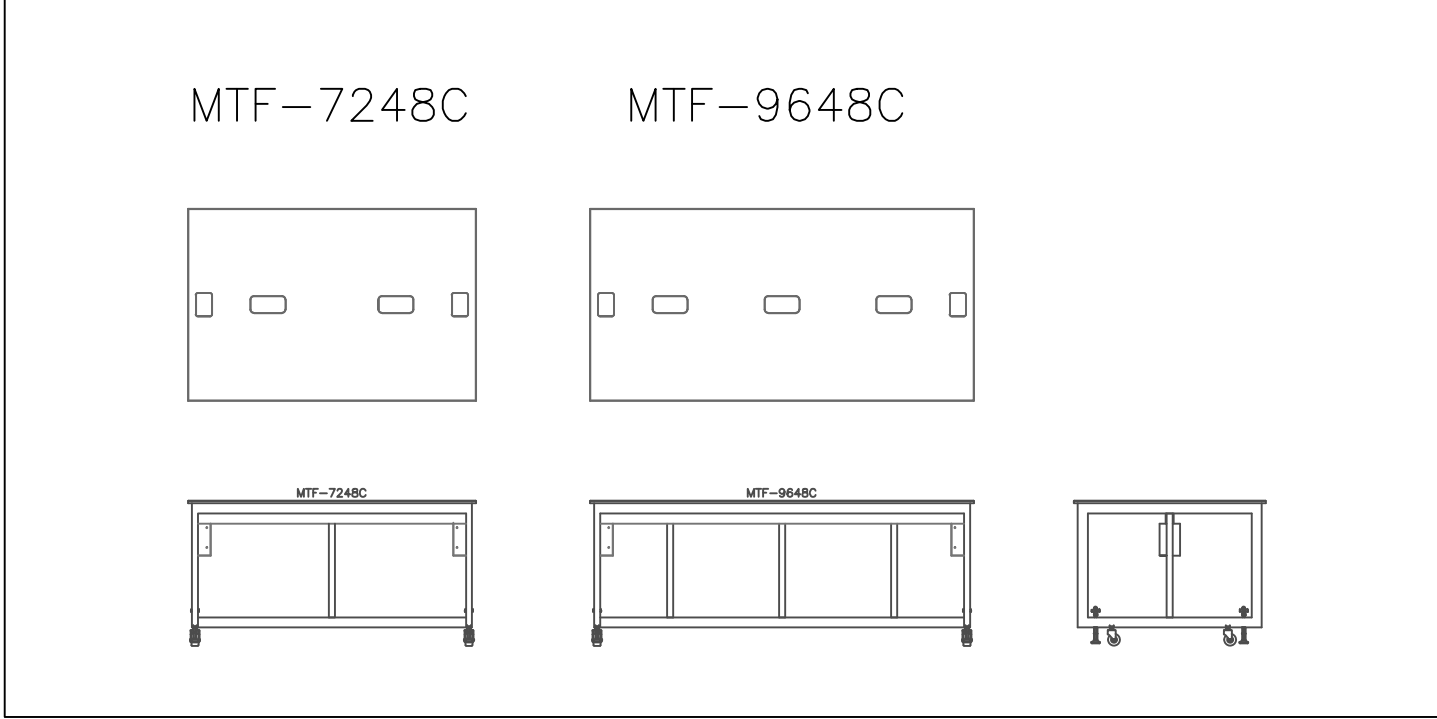

FUME HOOD "A" MOBILE CABINETS

- 24" HIGH, 22" DEEP
- WORK SURFACE/COUNTERTOP SUPPLIED BY LF SYSTEMS:
(1/4" THICK PHENOLIC RESIN WITH 1/4" OVERHANG ON ALL EDGES)

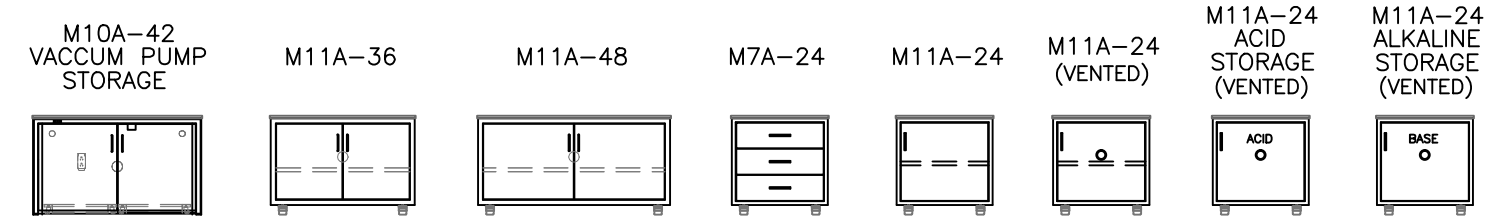

MOBILE TABLE & CABINET DETAILS:

STANDING HEIGHT MOBILE TABLE&CAB.

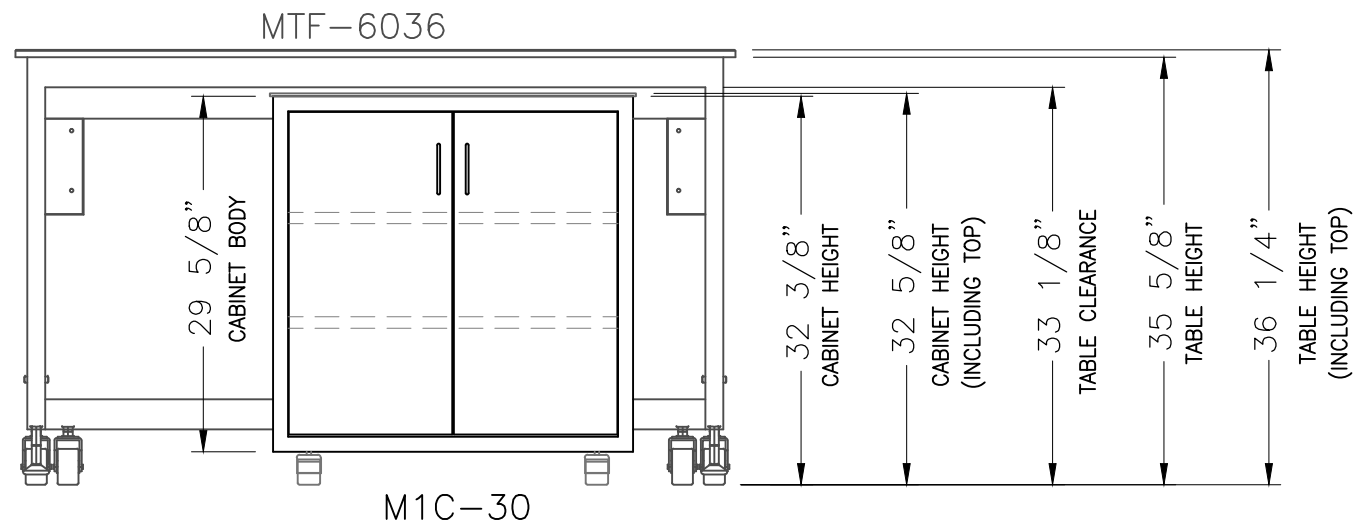

SITTING HEIGHT MOBILE TABLE&CAB.

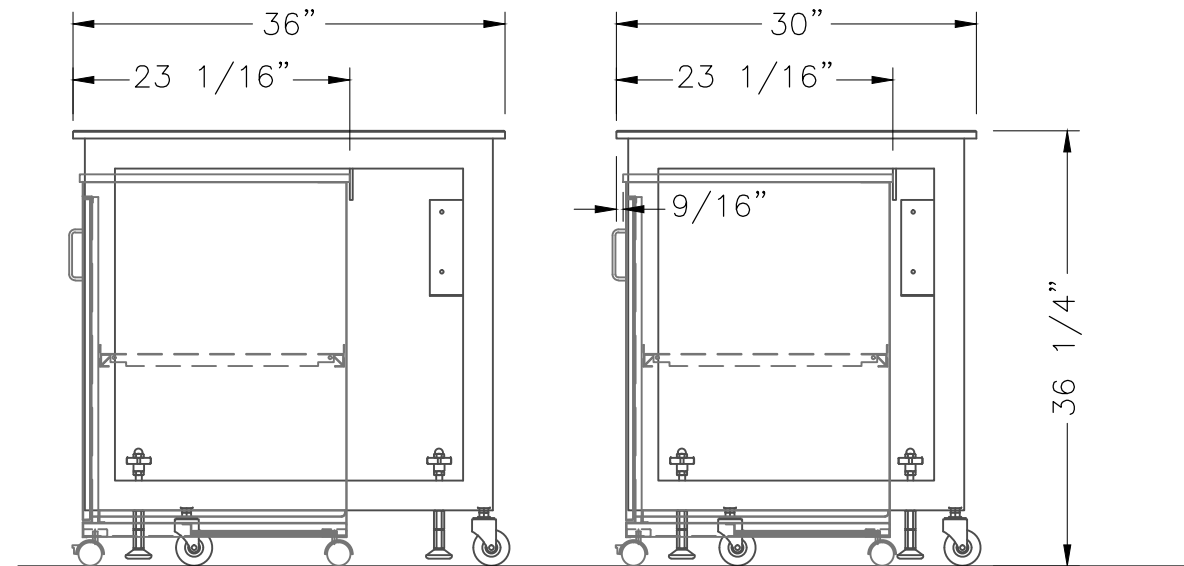
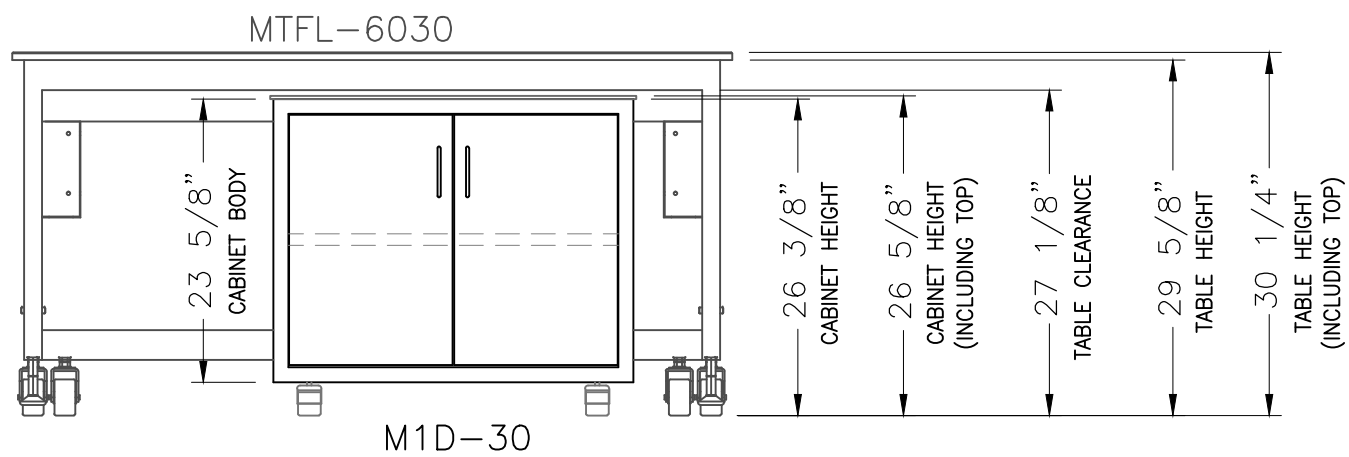

MOBILE FUMEHOOD CABINET DETAILS:

MOBILE FUMEHOOD&CAB.

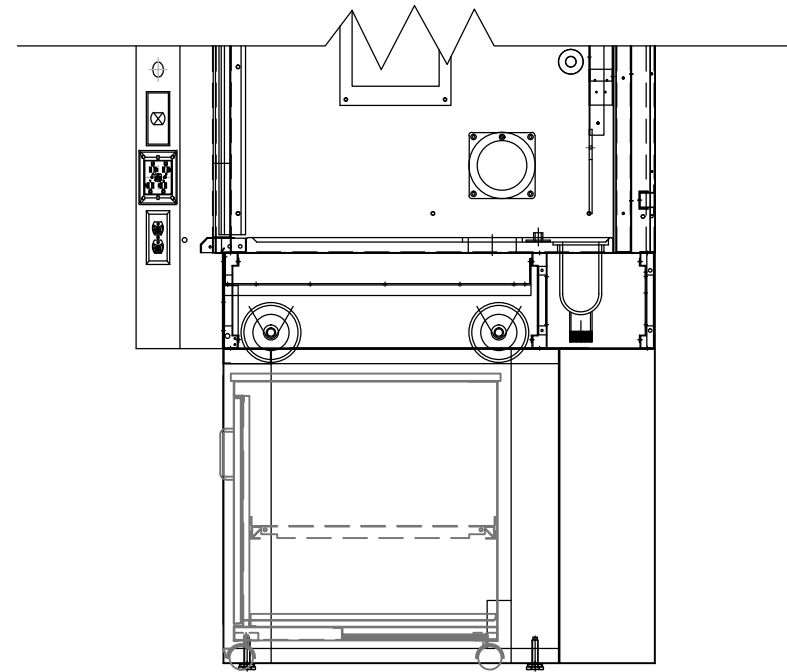
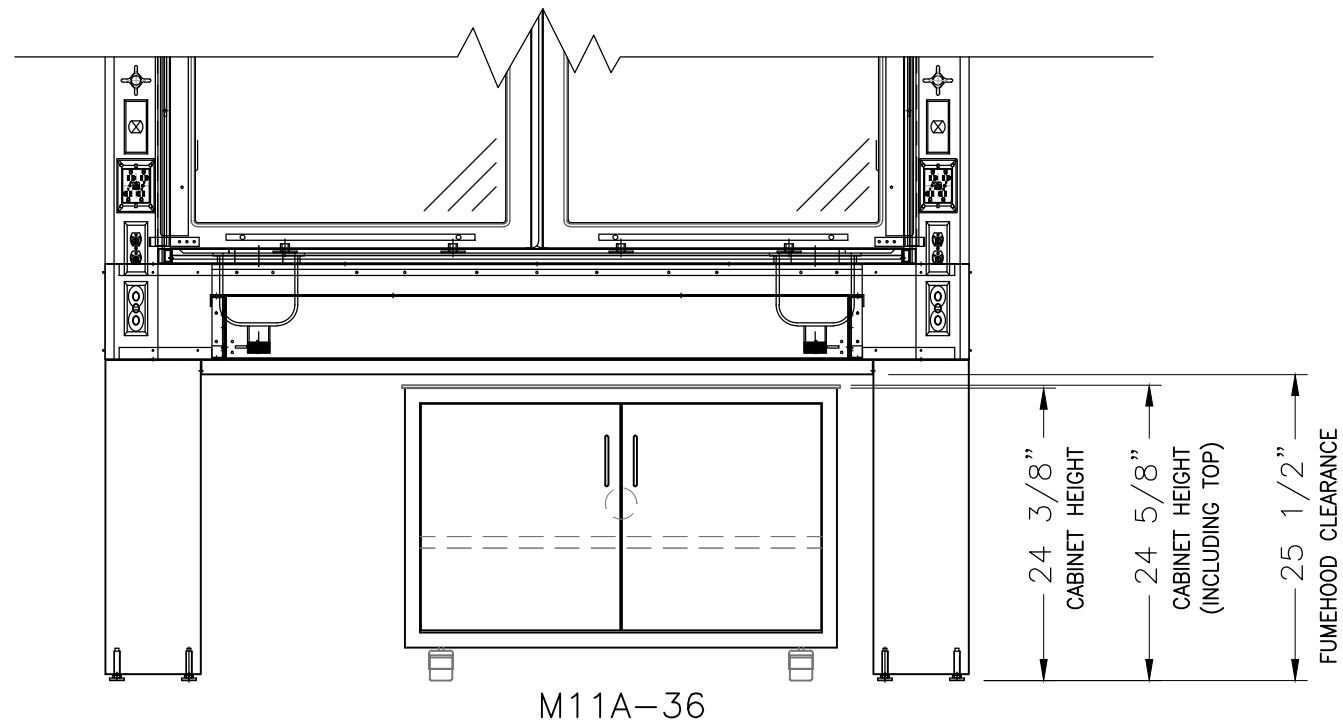

PROJECT

- LF SYSTEMS FLEXILAB SYSTEM -

249 OLD CHURCHMANS RD
NEW CASTLE, DE 19720
PHONE: 302-322-0460
FAX: 302-322-2849

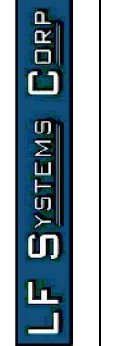

SCALE
NONE

DATE
01-01-18

DRAWN BY:
JMN

CHK'D BY:
GFH

JOB NO.
XXXX

SHEET NO.
05

REV. 0

REAGENT SHELVING FOR MOBILE TABLES:

- TWO SHELVES PER SYSTEM
- 1" THICK PHENOLIC SHELVES WITH A 1.25" HIGH APPLIED LIP ON (4) SIDES.
- UNIT TO BE ASSEMBLED & ATTACHED TO TABLES IN FIELD

MTUP-48
(FOR USE ON 48" WIDE TABLES)

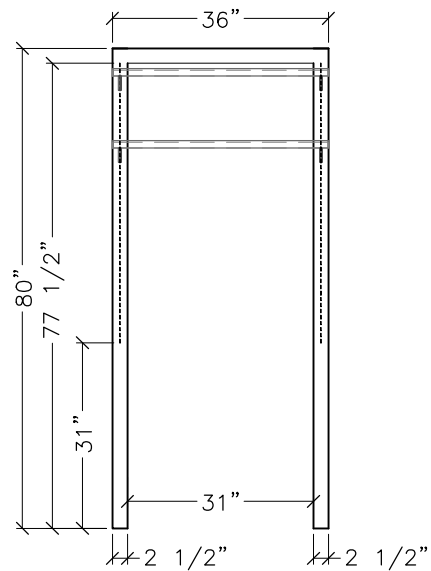

MTUP-54
(FOR USE ON 54" WIDE TABLES)

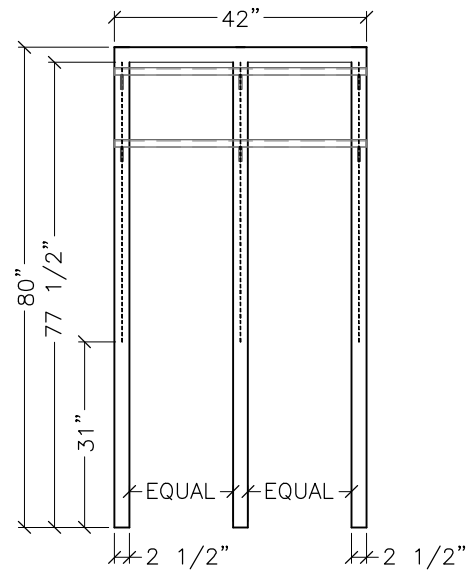

MTUP-60
(FOR USE ON 60" WIDE TABLES)

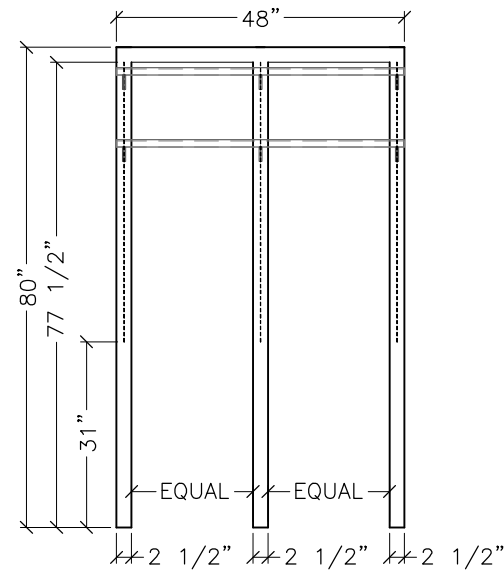

MTUP-66
(FOR USE ON 66" WIDE TABLES)

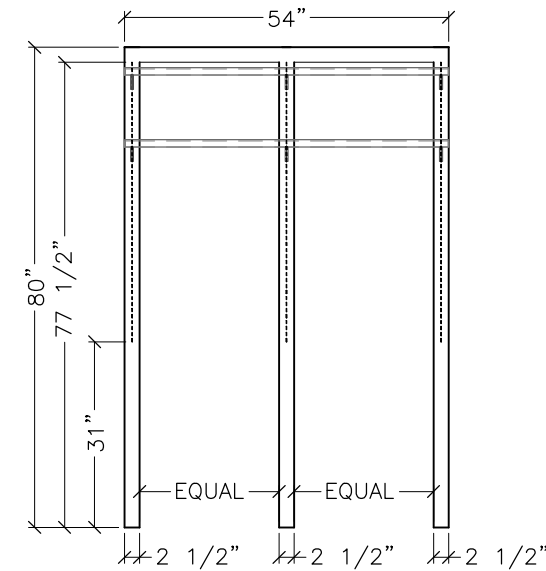

MTUP-72
(FOR USE ON 72" WIDE TABLES)

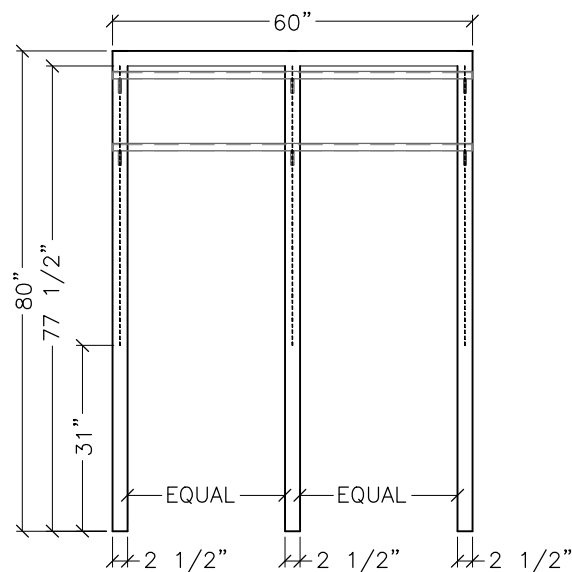

MTUP-84
(FOR USE ON 84" WIDE TABLES)

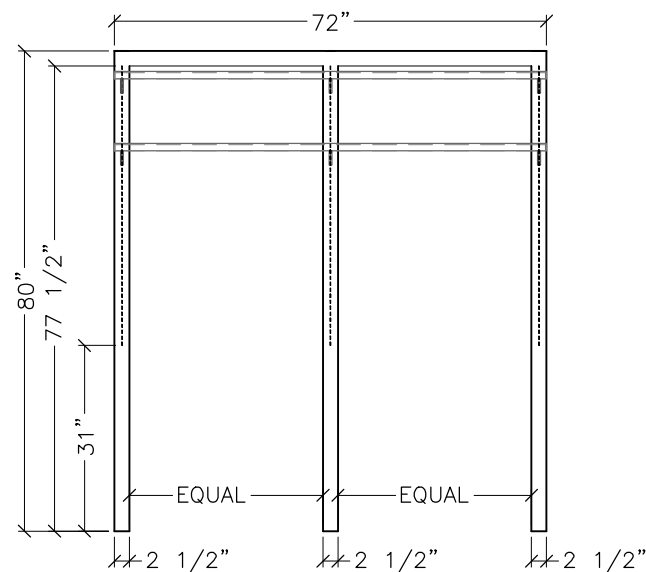

MTUP-96
(FOR USE ON 96" WIDE TABLES)

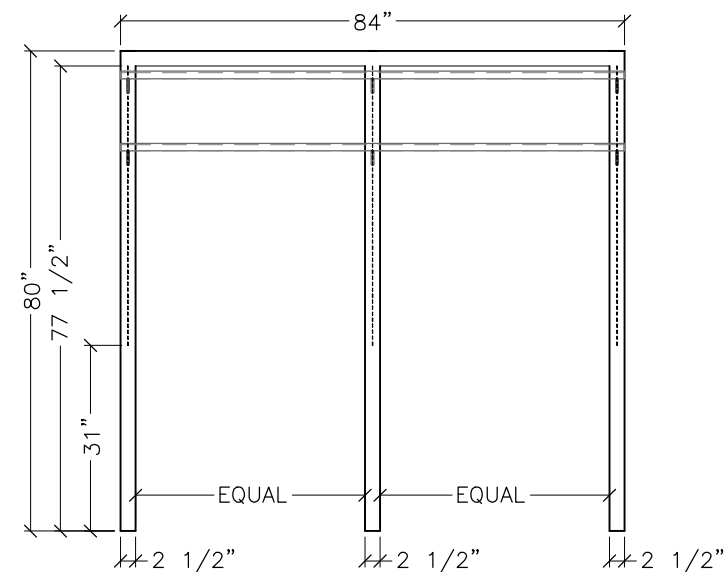

SIDE VIEW:
(TYPICAL ALL)

